

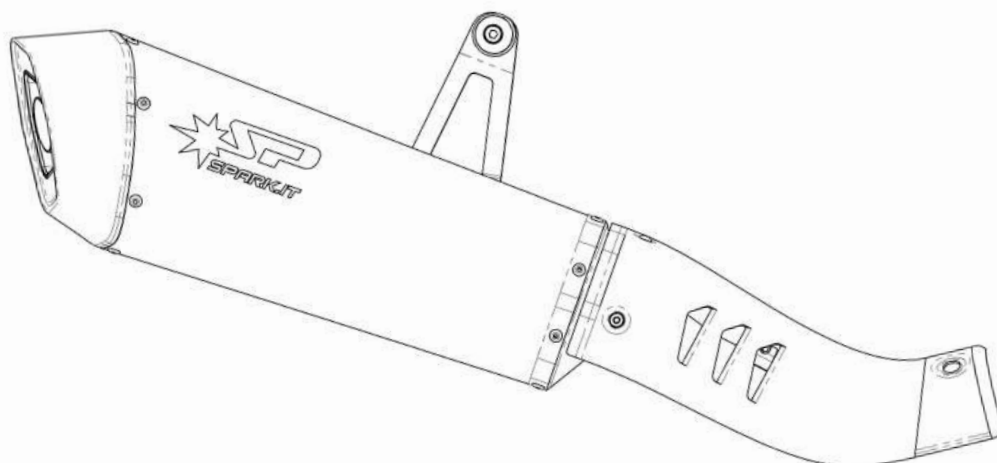

PRODUCT INSTALLATION INSTRUCTION MANUAL

MODELLO: HONDA AFRICA TWIN



SMONTAGGIO ORIGINALE / REMOVING THE ORIGINAL EXHAUST

1. Rimuovere la vite del paracalore e smontarlo. Poi rimuovere anche le 4 viti del supporto del paracalore smontandolo dalla moto.

1. *Unscrew marked bolts and remove heat shield off the stock exhaust*

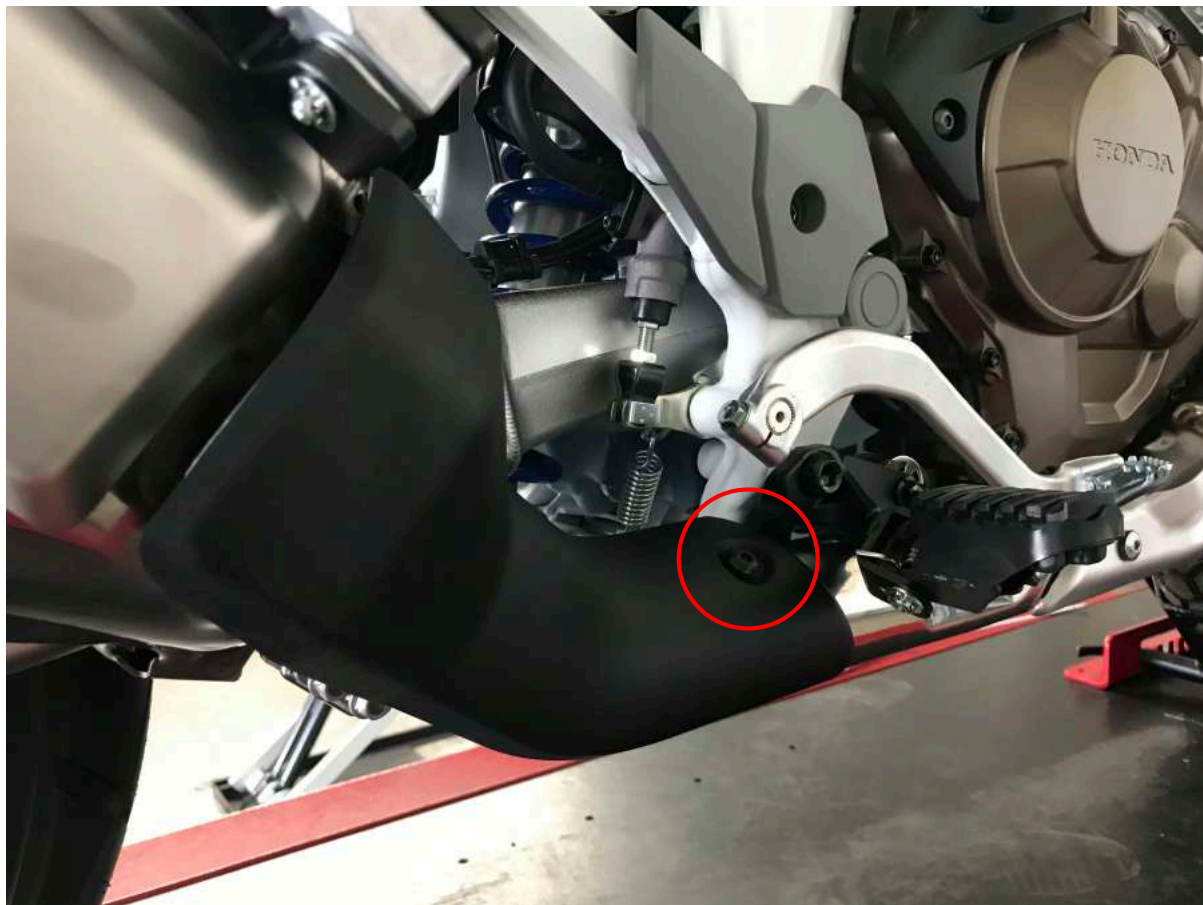

SMONTAGGIO ORIGINALE / REMOVING THE ORIGINAL EXHAUST

2. Rimuovere la pedana passeggero destra fissata al telaio.

2. Remove right passenger foot peg off the motorcycle



3. Rimuovere le 2 viti contrassegnate in rosso e rimuovere la protezione della valvola.

3. Unscrew marked bolts and remove the exhaust valve cover



4. Smontare i cavi della valvola allentando i 2 dadi contrassegnati in rosso.

4. Untighten marked nuts and remove cables off the exhaust valve.



SMONTAGGIO ORIGINALE / REMOVING THE ORIGINAL EXHAUST

5. Rimuovere la vite della staffa silenziatore e allentare la fascetta stringitubo. Poi rimuovere il silenziatore originale.

5. Remove the original screws marked in red color below and loosen the original clamp. Then, remove the original silencer



SMONTAGGIO ORIGINALE / REMOVING THE ORIGINAL EXHAUST

6. Rimuovere le 7 viti del parafrango che sostengono il servomotore della valvola

6. Unscrew the 7 marked bolts, than remove plastic mudguard

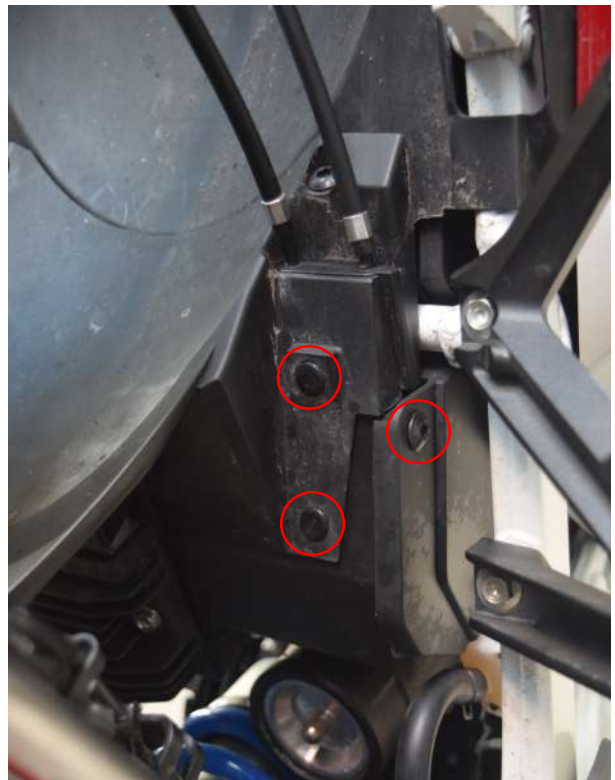

7. Scollegare cavo il connettore del servomotore della valvola di scarico

7. Disconnect the exhaust valve's servo motor connector

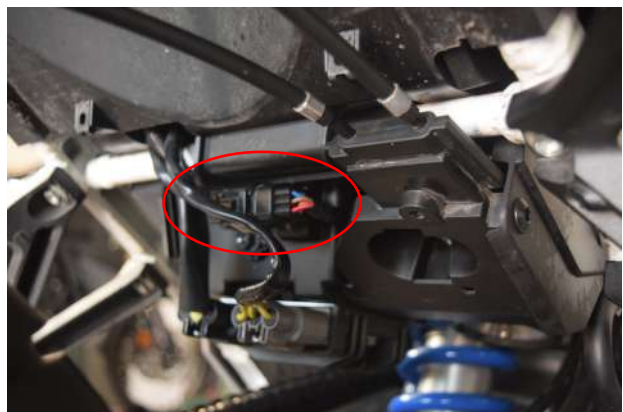
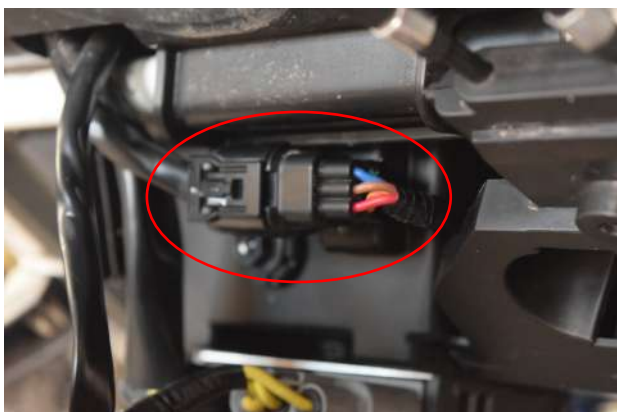

SMONTAGGIO ORIGINALE / REMOVING THE ORIGINAL EXHAUST

8. Smontare il servomotore della valvola dalla moto e rimuovere le 3 viti contrassegnate in rosso

8. *Unscrew the 3 marked bolts and remove the plastic cover off the servo motor*

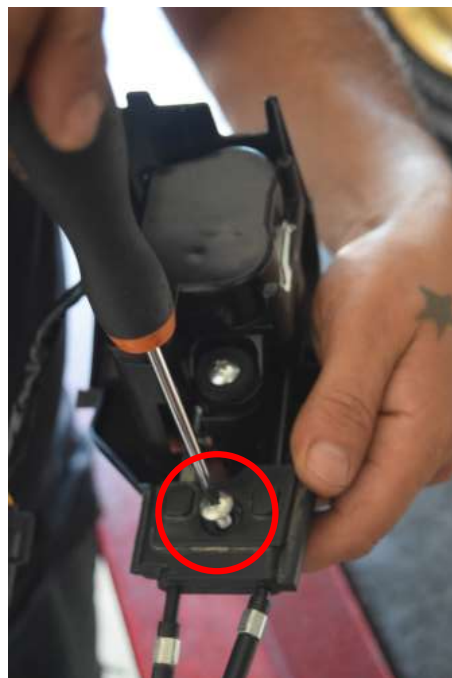

SMONTAGGIO ORIGINALE / REMOVING THE ORIGINAL EXHAUST

9. Rimuovere i cavi, poi la ruota del servomotore togliendo la vite contrassegnata in rosso

9. Remove both cables and the servo wheel, unscrew the marked bolt.

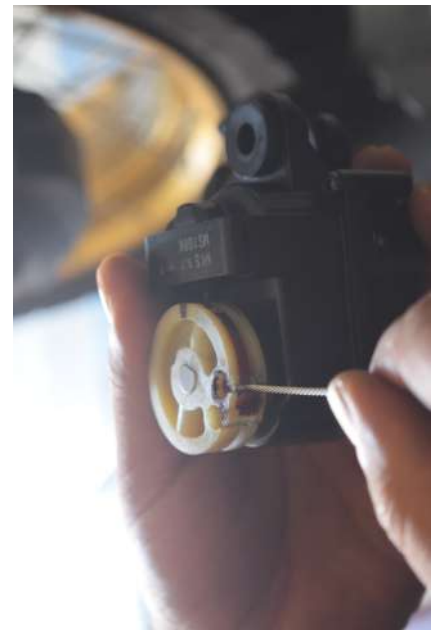
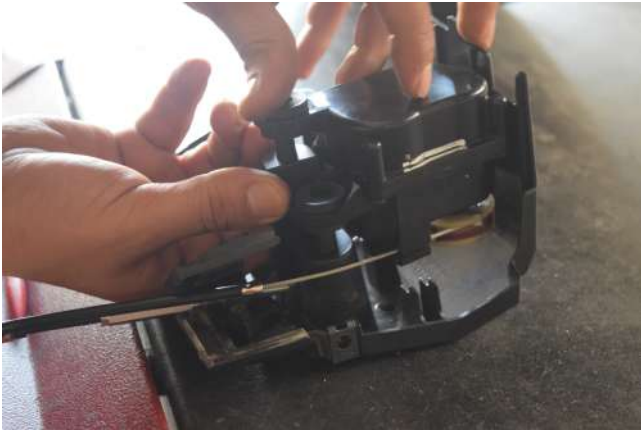

INSTALLAZIONE / INSTALLING SPARK EXHAUST

1. Montare il simula valvola Spark riutilizzando la vite originale contrassegnata in rosso

1. Position Spark valve by using the original screw marked in red.



2. Ricollegare il connettore del servomotore della valvola di scarico

2. Reconnect the exhaust valve servo motor connector

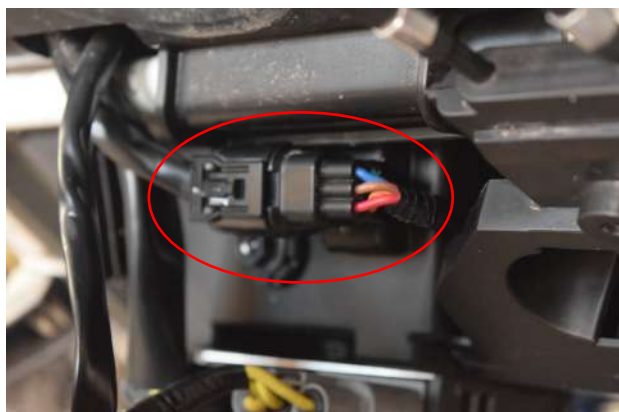

INSTALLAZIONE / INSTALLING SPARK EXHAUST

2. Posizionare il silenziatore Spark utilizzando la fascetta in dotazione

2. Mount the silencer with Spark clamp



3. Fissare la staffa silenziatore al telaio utilizzando la vite e i distanziali Spark.

3. Fix Spark silencer with the screw and spacer Spark.



INSTALLAZIONE / INSTALLING SPARK EXHAUST

4. Stringere la fascetta

4. Tighten Spark clamp



5. Montare le 2 clip per il fissaggio delle viti del paracalore sul silenziatore. Poi utilizzare il gommino del paracalore originale sul paracalore in carbonio Spark.

5. Mount the 2 clips for fixing the heat shield screws to the silencer. Then use the original heat shield rubber on the Spark carbon heat shield.



6. Posizionare il paracalore con le due viti e rondelle Spark. Poi utilizzare la vite originale per il foro con il gommino originale precedentemente montato.

6. Place the heat shield with the two Spark screws and washers. Then use the original screw for the hole with the original rubber previously mounted.





@Spark.Exhaust.Technology



@SPARKEHAUST



GRAZIE per aver scelto un prodotto Spark Exhaust Technology!

100% made in Italy, 100% realizzato per dar forma alla passione per le 2 ruote.

Con il tuo acquisto, sei entrato a far parte del mondo Spark: inviaci a info@spark.it foto o video della tua moto col nostro scarico, le inseriremo sulla nostra pagina ufficiale Facebook e Instagram.

Inoltre, se hai suggerimenti, idee, osservazioni... saremo ben felici di ascoltare il tuo parere per migliorarci!

Thank you for choosing Spark Exhaust Technology!

100% Made in Italy, 100% produced to give shape to passion for 2 wheels.

As a result of your purchase, you are part of our world: send us at info@spark.it a photo or video of your motorbike with Spark exhaust, we will publish them on our official Facebook page and Instagram.

Moreover, if you have any suggestion, idea or remark, we will be happy to know your opinion to improve more and more!